

SERIES F670S1

ENGINEERING DATA SHEET

RAILWAY RELAY
1 PDT-DB-DM+4PDT, 3 AMP / 72VDC



APPLICATION NOTES:

[001](#)
[003](#)
[004](#)
[007](#)

APPLICABLE SOCKET:

[SF600-2F](#)

Polarized, non latching, hermetically sealed relay

Contact arrangement **1 PDT-DB-DM + 4PDT**

Coil supply **Direct current**

PRINCIPLE TECHNICAL CHARACTERISTICS

Contact rating (1 PDT-DB-DM) **72 Vdc / 3 Amp**

Contact rating (4 PDT) **72 Vdc / 1 Amp**

Weight **< 110 grams**

Dimensions of can without hardware **26.7mm x 25.7mm x 37.7mm max**

Balanced-force design.

Tin plated, hermetically sealed metal can.

Non-overlapping contact arrangement, see note 5 page 4.

CONTACT ELECTRICAL CHARACTERISTICS

Nominal contact voltage (Vdc)	Contact rating in Amps				Level	Minimum operating cycles
	Simple break		Double break			
	resistive load	inductive load (L/R=30ms)	resistive load	inductive load (L/R=30ms)		
72 V	1	0.6	3	1.2	High level	1,000,000 cycles
$5 \leq U \leq 90$ V	1 to 20mA	-	-	-	Low level	2,000,000 cycles
$15 \leq U \leq 35$ V	-	10 mA to 1.50 Amps	-	10 mA to 2.50 Amps	High level	2,000,000 cycles
$35 < U \leq 90$ V	-	10 mA to 0.50 Amps	-	10 mA to 1.00 Amps	High level	2,000,000 cycles
$90 < U \leq 140$ V	-	10 mA to 0.35 Amps	-	10 mA to 0.70 Amps	High level	2,000,000 cycles

Life expectancy for DC loads other than 72Vdc: See application note n°003 and n°004



Featuring **LEACH**® power and control solutions
www.esterline.com

AMERICAS
6900 Orangethorpe Ave.
P.O. Box 5032
Buena Park, CA 90622

EUROPE
2 Rue Goethe
57430 Sarralbe
France

ASIA
Units 602-603 6/F Lakeside 1
No.8 Science Park West Avenue
Phase Two, Hong Kong Science Park
Pak Shek Kok, Tai Po, N.T.
Hong Kong

Tel: (01) 714-736-7599
Fax: (01) 714-670-1145

Tel: (33) 3 87 97 31 01
Fax: (33) 3 87 97 96 86

Tel: (852) 2 191 3830
Fax: (852) 2 389 5803

Data sheets are for initial product selection and comparison. Contact Esterline Power Systems prior to choosing a component.

COIL CHARACTERISTICS (Vdc)**SERIES F670S1**

CODE	C	H	B	J	A	D	E	W	V
Nominal operating voltage	6	9	12	18	24	36	48	72	110
Maximum operating voltage at +85°C	7.5	11.3	15	22.5	33	45	60	90	138
Minimum operating voltage at +70°C, coil previously energized at 1.15 Un or at 85° coil previously energized at Un	4.2	6.3	8.4	12.6	18.5	25.2	33.6	50.4	77
Hold voltage at +85°C	2.6	3.2	4.2	6.3	7.5	12.5	17.5	22.5	35
Drop-out voltage at -40°C	0.3	0.45	0.6	0.9	1.5	1.8	2	3.6	5.5
Coil resistance in Ohms $\pm 10\%$ at +25°C	10	22	40	90	210	350	620	1300	3200
Maximum back EMF (Volts) (with P suffix)	-15	-15	-15	-42	-42	-65	-65	-100	-140

GENERAL CHARACTERISTICS

Operating temperature	-40°C to +85°C
Dielectric strength at sea level	
All terminals to ground	1500 Vrms / 50 Hz
Contact to contact, isolated terminals	1500 Vrms / 50 Hz
Initial insulation resistance at 500 Vdc	>100 M Ω
Sinusoidal vibration	20 G / 30 to 3000 Hz
Shock	100 G / 6 ms 30 G / 18 ms
Maximum contact opening time under vibration and shock	10 μ s
Operate time at nominal voltage	15 ms max
Release time	15 ms max
Bounce time	1 ms max
Contact resistance at 5 Amps (simple break)	15 m Ω max
Contact resistance at 5 Amps (double break)	20 m Ω max

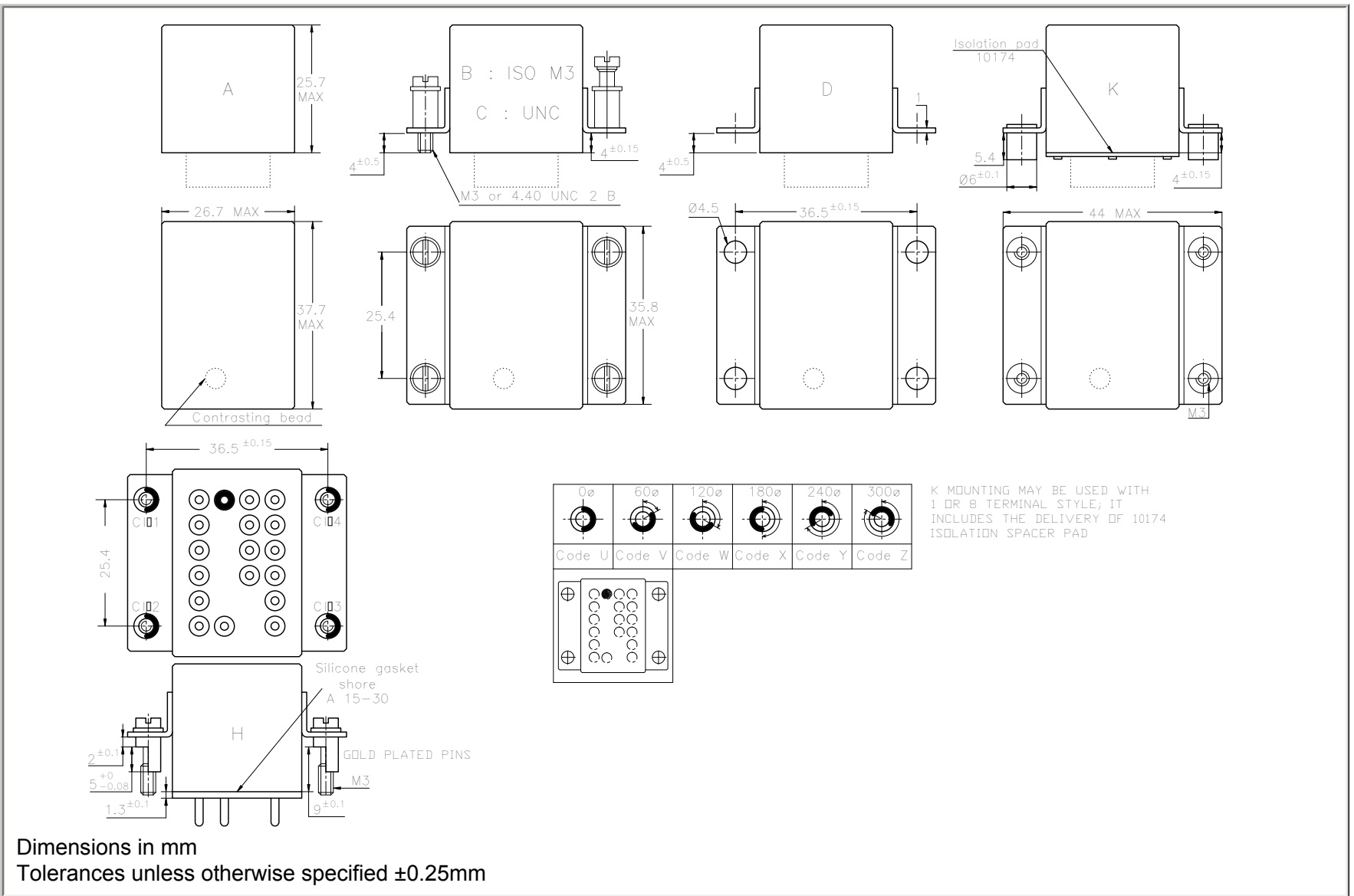

SCHEMATIC DIAGRAM

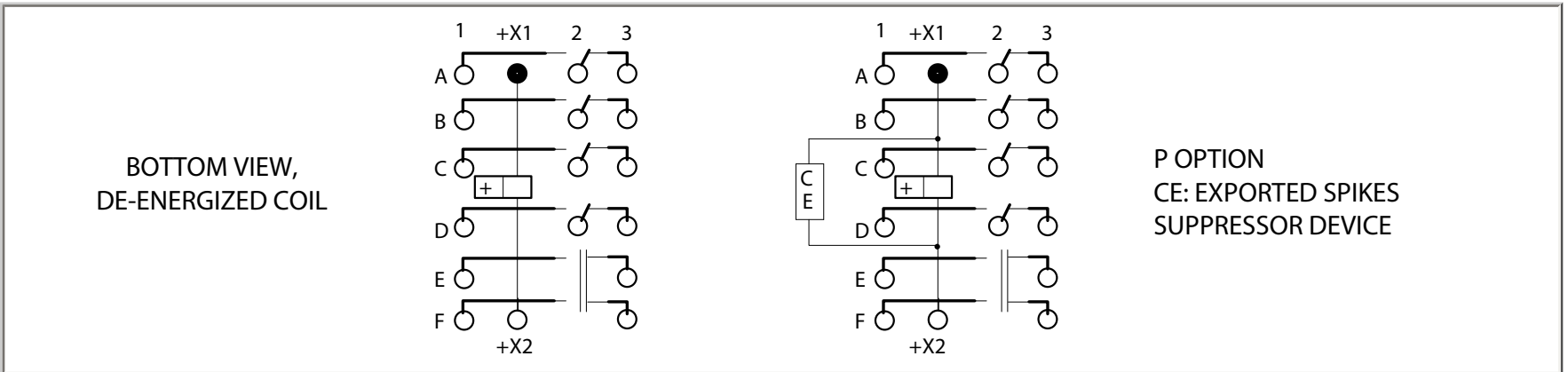

TERMINAL TYPES

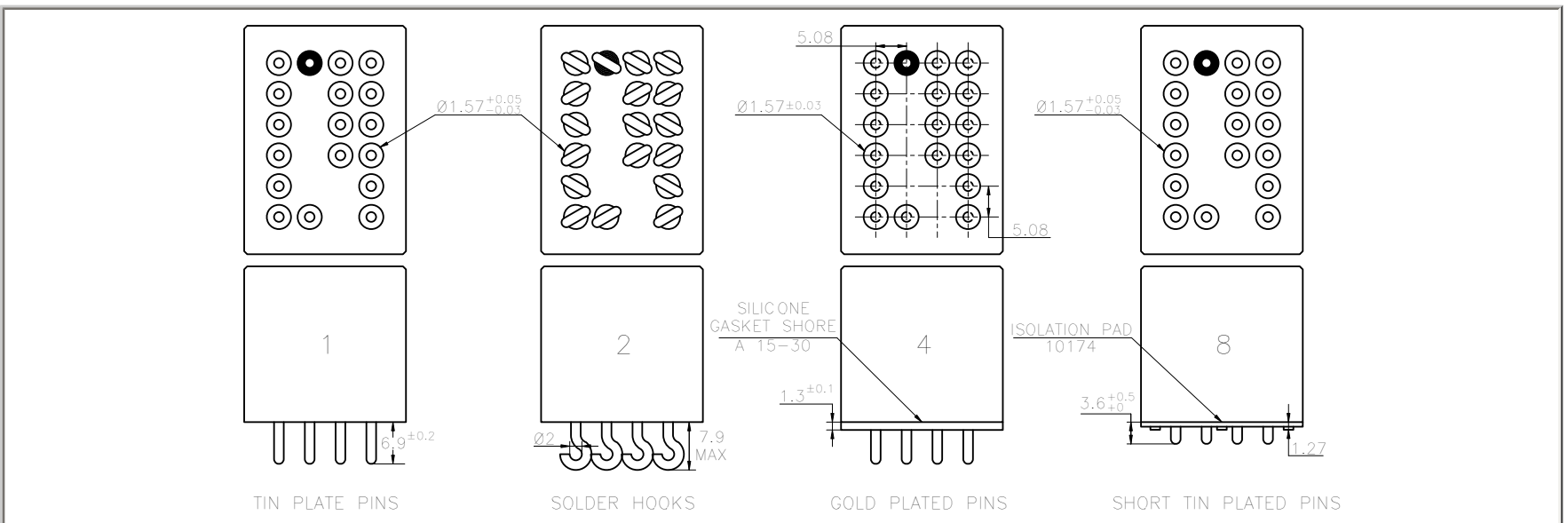

	F670S1	B	4	A	P	AND/OR	XXX
Basic series designation_____							
1-Mounting Styles (A,B,C,D,K,H)_____							
2-Terminal Types(1,2,4,8)_____							
3-Coil Voltage (C,H,B,J,A,D,E,W,V)_____							
4-Coil Suppression (P)_____							
5-Coding keys for H mounting style_____							

NOTES

1. Relays with B, D mounting styles and terminal type 4 are compatible with socket SF600CE40E.
2. Relays with H mounting style are compatible with socket SF600-2F.
3. Isolation spacer pads for PCB mounting available on request.
4. For other mounting styles or terminal types or coding, please contact factory.
5. Non overlapping arrangement insures that if one of the NO or NC contacts is accidentally welded, none of the other contacts can be transfered to another state.
6. For "H" mount relays with coil suppression, customer should specify the code.

Double break-double make contacts E and F do not appear in this chart, they are typically high level.

CODING CHART FOR H MOUNTING WITHOUT COIL SUPPRESSION

Type of contact operation			Nominal load voltage				
pole	low level	high level	24 volts	48 volts	72 volts	110 volts	36 volts
A		X	UVUV	VVUV	WVUV	XVUV	YVUV
B		X					
C		X					
D		X					
A	X		UVVU	VVVU	WVVU	XVVU	YVVU
B		X					
C		X					
D		X					
A	X		UVWU	VWU	WWU	XVWU	YVWU
B	X						
C		X					
D		X					
A	X		UVXU	VXU	WXU	XVXU	YVXU
B	X						
C	X						
D		X					
A	X		UVYU	VYU	WYU	XVYU	YVYU
B	X						
C	X						
D	X						

TYPICAL CHARACTERISTICS

- Coil resistance temperature change: See application note n°001
- Coil L/R ratio for all types of DC coils is = 11 ms

CORRECTION DUE TO COIL COPPER WIRE RESISTANCE CHANGE IN TEMPERATURE

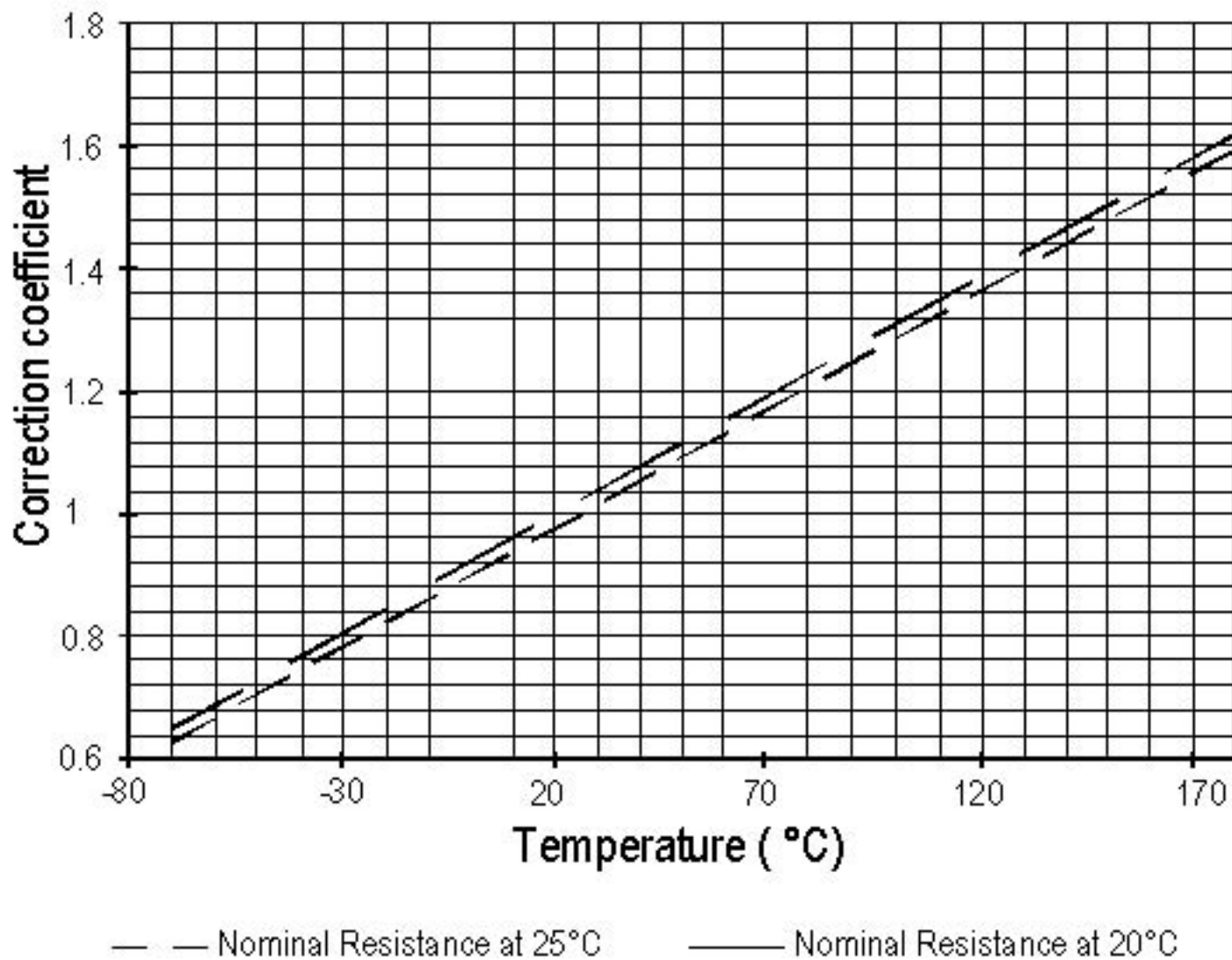

Example: Coil resistance at 25°C: 935 ohms. What is it at 125°C?
 Correction coefficient on diagram is: 1.39 at 125°C. R becomes: $935 \times 1.39 = 1299$ Ohms

Correction also applies to operating voltages

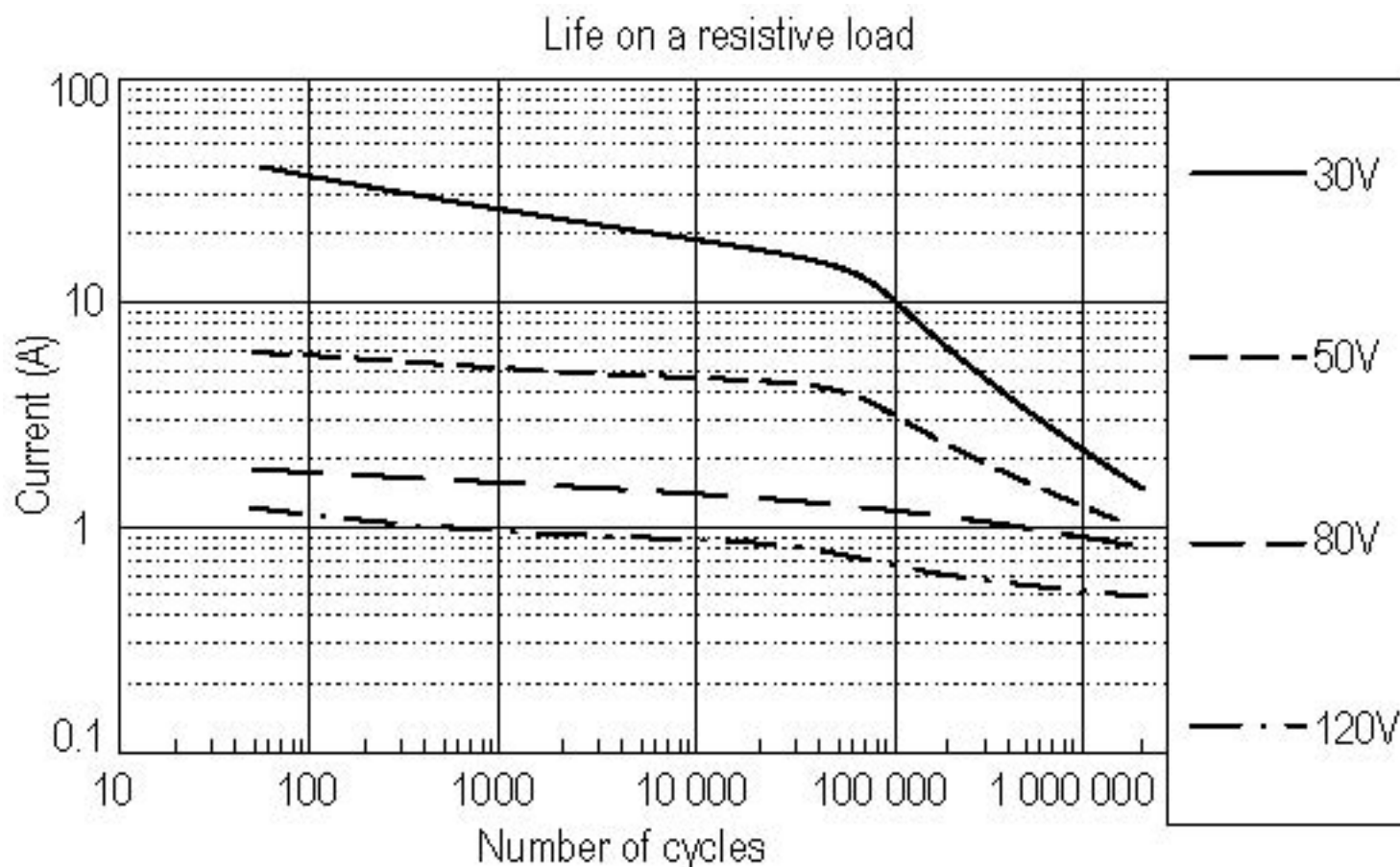

Current greater than 15A cannot be conducted permanently.
 For $I \cdot t$ product $> 2000 \text{ A}^2 \cdot \text{s}$, please consult us.

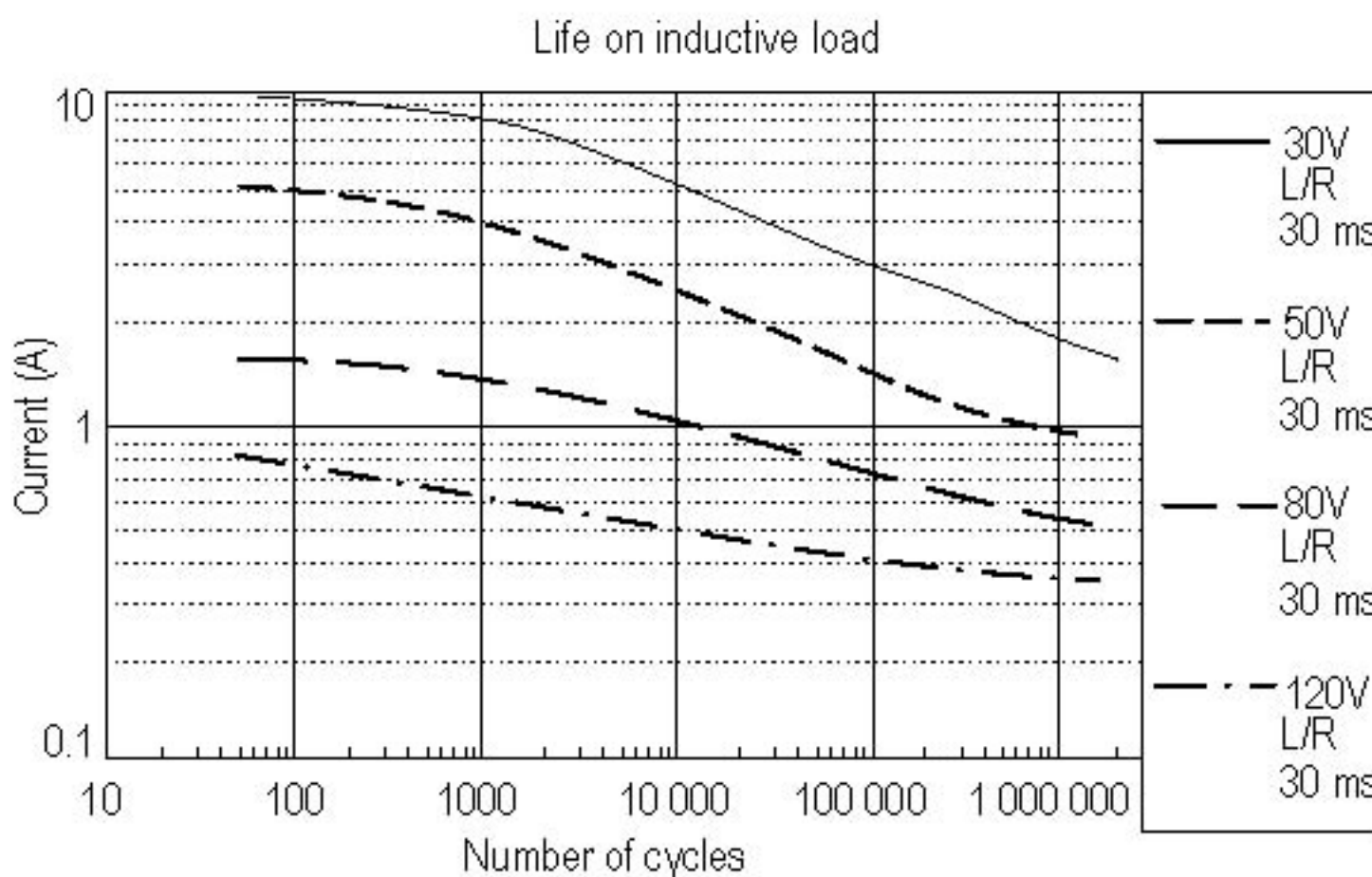

To define life at values of L/R different to 30 ms, it is possible to consider the product N cycles X L/R = constant. This for a given current and voltage.

For example if a 80 V L/R 30ms 0.75 A, life is found on the graph at 100,000 cycles. For a L/R of 10 ms, and the same current, 0.75 A, life should be $100,000 \times 30 / 10 = 300,000$ cycles.

LIFE CAPABILITY VERSUS VOLTAGE

Relay Series FD370, FD470, FD670

Life on a resistive load

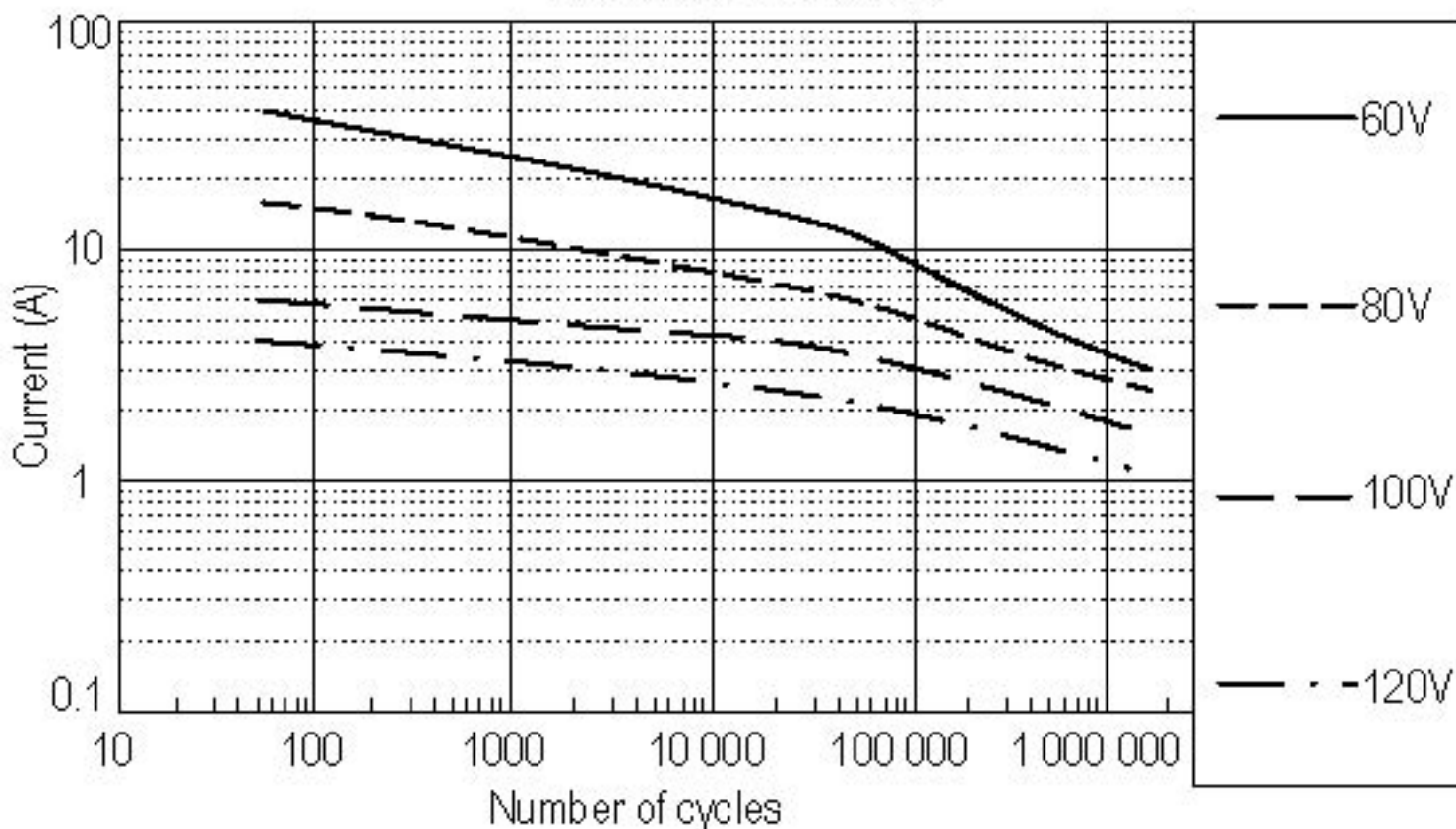

Current greater than 15A cannot be conducted permanently.
 For $t \cdot I$ product > 2000 A².s, please consult us.

Life on inductive load

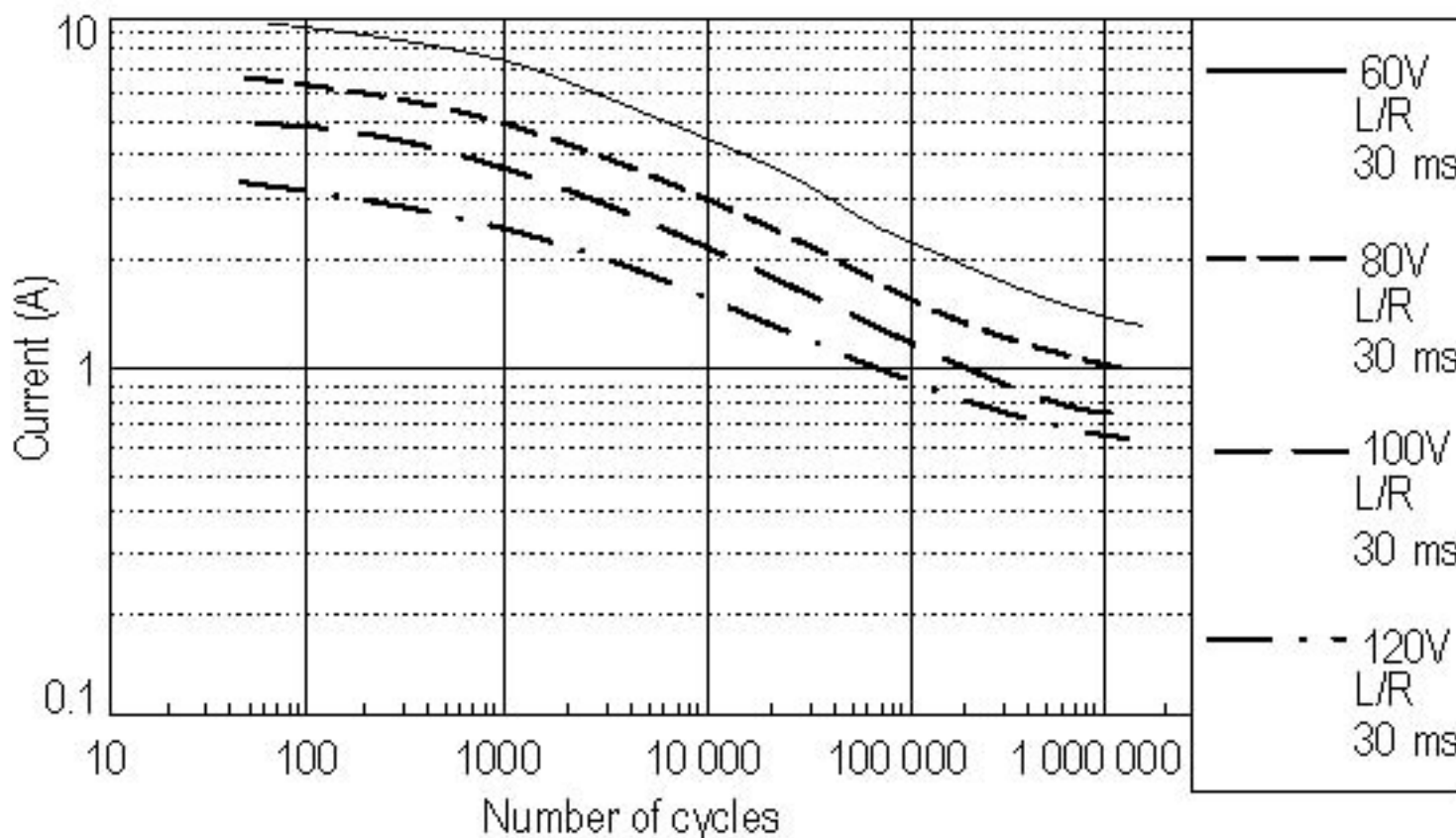

To define life at values of L/R different to 30 ms, it is possible to consider the product N cycles X L/R = constant. This for a given current and voltage.
 For example if a 80 V L/R 30ms 2 A, life is found on the graph at 100,000 cycles. For a L/R of 10 ms, and the same current, 2 A, life should be $100,000 \times 30 / 10 = 300,000$ cycles.

SUPPRESSOR DEVICES FOR RELAY COILS

The inductive nature of relay coils allows them to create magnetic forces which are converted to mechanical movements to operate contact systems. When voltage is applied to a coil, the resulting current generates a magnetic flux, creating mechanical work. Upon deenergizing the coil, the collapsing magnetic field induces a reverse voltage (also known as back EMF) which tends to maintain current flow in the coil. The induced voltage level mainly depends on the duration of the deenergization. The faster the switch-off, the higher the induced voltage.

All coil suppression networks are based on a reduction of speed of current decay. This reduction may also slow down the opening of contacts, adversely effecting contact life and reliability. Therefore, it is very important to have a clear understanding of these phenomena when designing a coil suppression circuitry.

Typical coil characteristics

On the graph below, the upper record shows the contacts state. (High level NO contacts closed, low level NC contacts closed, intermediate state contact transfer). The lower record shows the voltage across the coil when the current is switched off by another relay contact.

The surge voltage is limited to -300V by the arc generated across contact poles. Discharge duration is about 200 microseconds after which the current change does not generate sufficient voltage. The voltage decreases to the point where the contacts start to move, at this time, the voltage increases due to the energy contained in the NO contact springs. The voltage decreases again during transfer, and increases once more when the magnetic circuit is closed on permanent magnet.

Operating times are as follows:
 Time to start the movement 1.5ms
 Total motion time 2.3ms
 Transfer time 1.4ms

Contact State

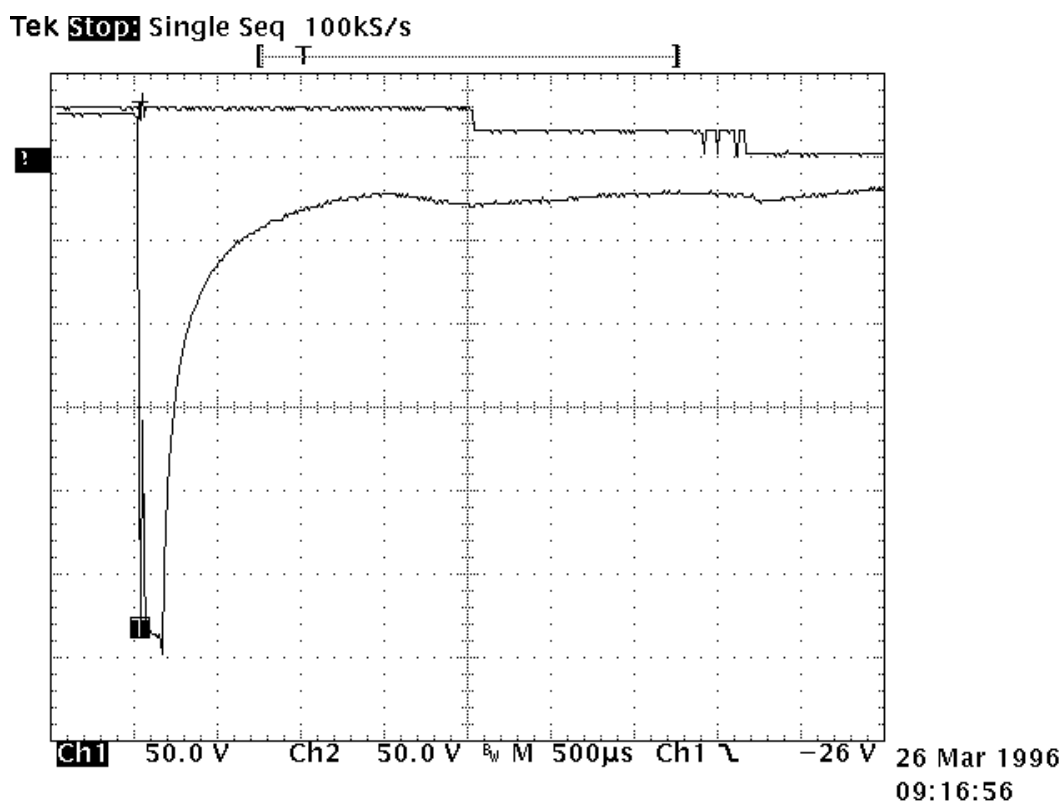

Types of suppressors:

Passive devices.

The resistor capacitor circuit

It eliminates the power dissipation problem, as well as fast voltage rises. With a proper match between coil and resistor, approximate capacitance value can be calculated from:

$$C = 0.02 \times T / R, \text{ where}$$

T = operating time in milliseconds

R = coil resistance in kiloOhms

C = capacitance in microFarads

The series resistor must be between 0.5 and 1 times the coil resistance. Special consideration must be taken for the capacitor inrush current in the case of a low resistance coil.

The record shown opposite is performed on the same relay as above. The operation time becomes:

- time to start the movement 2.3ms

- transfer time 1.2ms

The major difficulty comes from the capacitor volume. In our example of a relay with a 290Ω coil and time delay of 8 ms, a capacitance value of $C=0.5 \mu\text{F}$ is found. This non polarized capacitor, with a voltage of 63V minimum, has a volume of about 1cm^3 . For 150V, this volume becomes 1.5cm^3 .

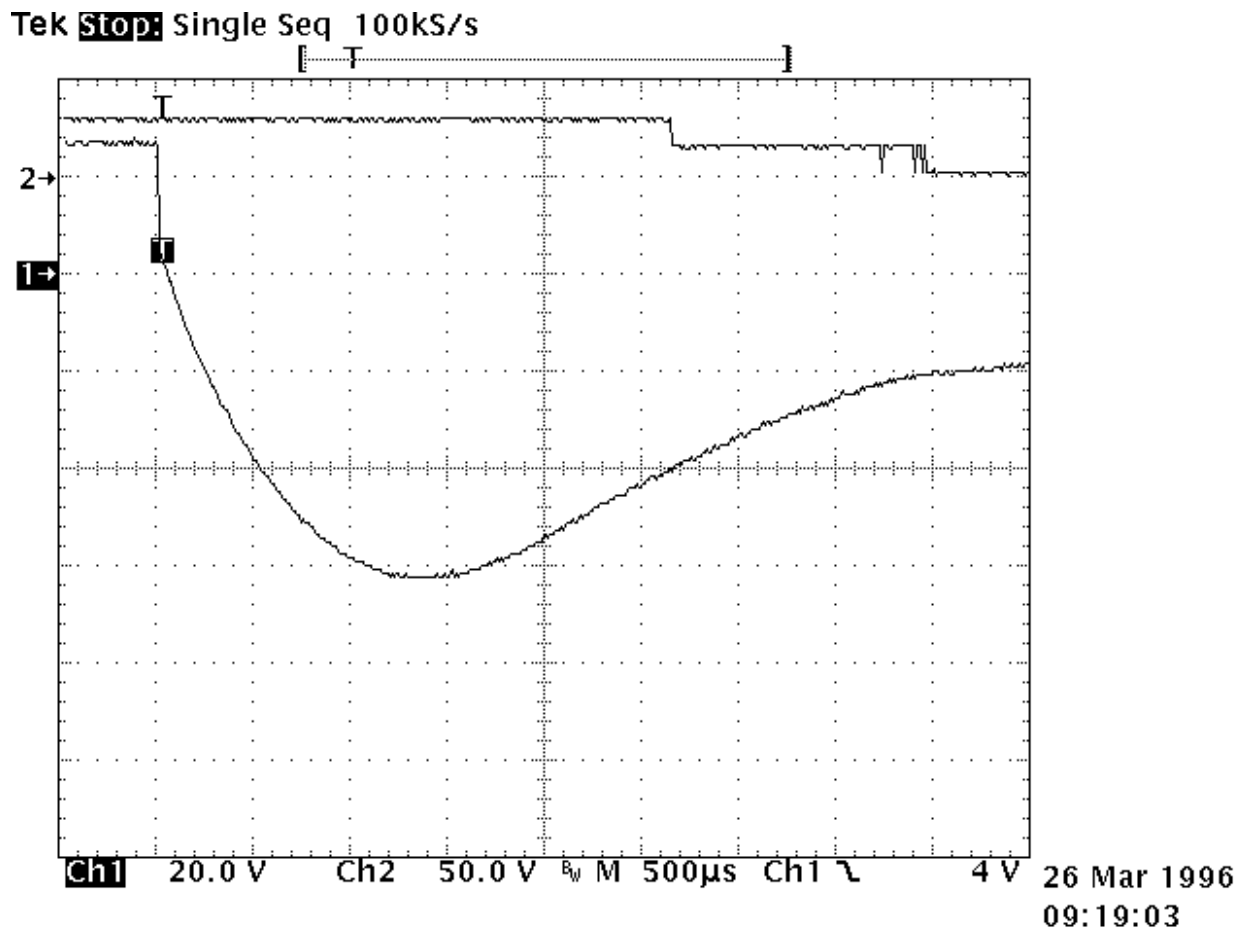

The bifilar coil

The principle is to wind on the magnetic circuit of the main coil a second coil shorted on itself. By a proper adaptation of the internal resistance of this second coil it is possible to find an acceptable equilibrium between surge voltage and reduction of the opening speed. To be efficient at fast voltage changes, the coupling of two coils must be perfect. This implies embedded windings. The volume occupied by the second coil reduces the efficiency of the main coil and results in higher coil power consumption. This method cannot be applied efficiently to products not specifically designed for this purpose.

The resistor (parallel with the coil)

For efficient action, the resistor must be of the same order of magnitude as the coil resistance. A resistor 1.5 times the coil resistance will limit the surge to 1.5 times the supply voltage. Release time and opening speed are moderately affected. The major problem is the extra power dissipated.

Semi-conductor devices

The diode

It is the most simple method to totally suppress the surge voltage. It has the major disadvantage of the higher reduction of contact opening speed. This is due to the total recycling, through the diode, of the energy contained in the coil itself. The following measurement is performed once again on the same relay. Operation times are given by the upper curve:

- time to start the movement 14ms
- transfer time 5ms

These times are multiplied by a coefficient from 4 to 8.

The lower curve shows the coil current. The increase prior to NO contact opening indicates that the contact spring dissipates its energy. At the opening time the current becomes constant as a result of practically zero opening speed.

Due to this kind of behavior, this type of suppression must be avoided for power relays. For small relays which have to switch low currents of less than 0.2 A, degradation of life is not that significant and the method may be acceptable.

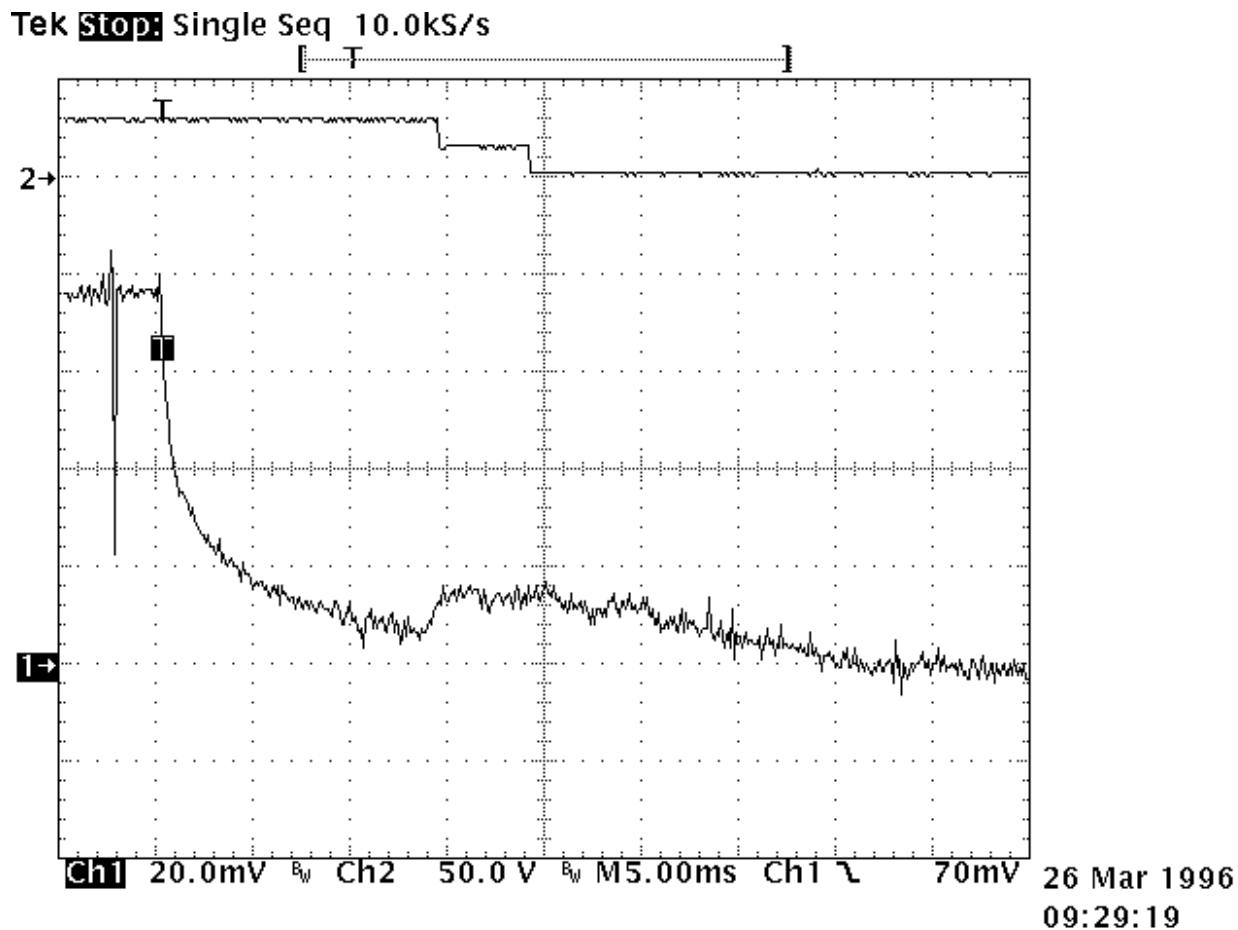

The diode + resistor network

It eliminates the inconvenience of the resistor alone, explained above, and it limits the action of a single diode. It is now preferred to use the diode + zener network.

The diode + zener network

Like the resistor, the zener allows a faster decurrent decay. In addition it introduces a threshold level for current conduction which avoids the recycling of energy released during contact movement.

The lower curve on the opposite record demonstrates those characteristics. Voltage limitation occurs at 42V. The two voltage spikes generated by internal movement are at lower levels than zener conduction. As a result, no current is recycled in the coil.

The opening time phases are as follows:

- time to start the movement 2.6ms
- total motion time 2.4ms
- transfer time 1.4ms

The release time is slightly increased. The contacts' opening speed remains unchanged.

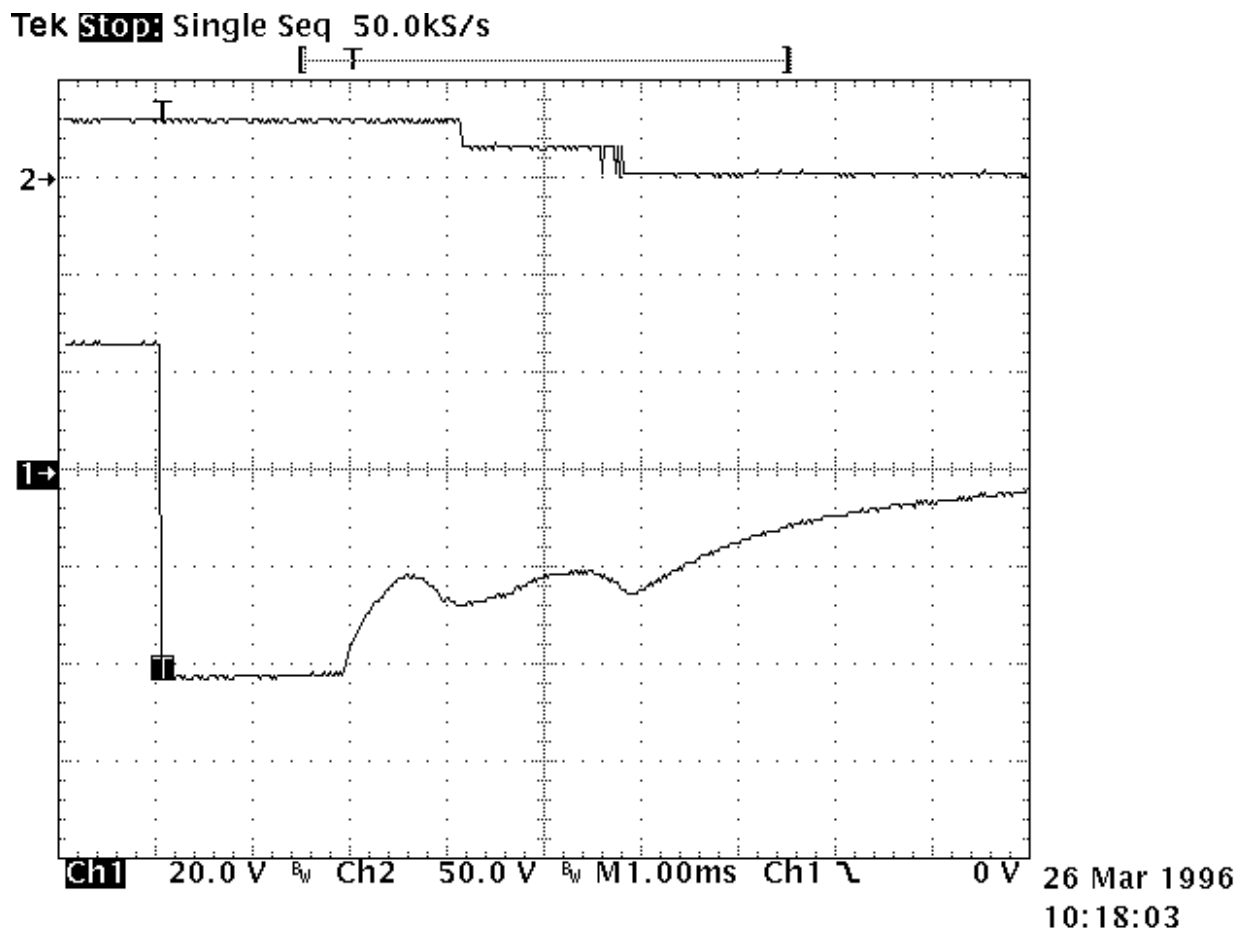

ENGINEERING DATA SHEET

SERIES SF600-2F

RAILWAY SOCKET
BASE - H MOUNTING STYLE



BASIC SOCKET SERIES DESIGNATION FOR:

Series F670, FD670, F670S1, F670S2

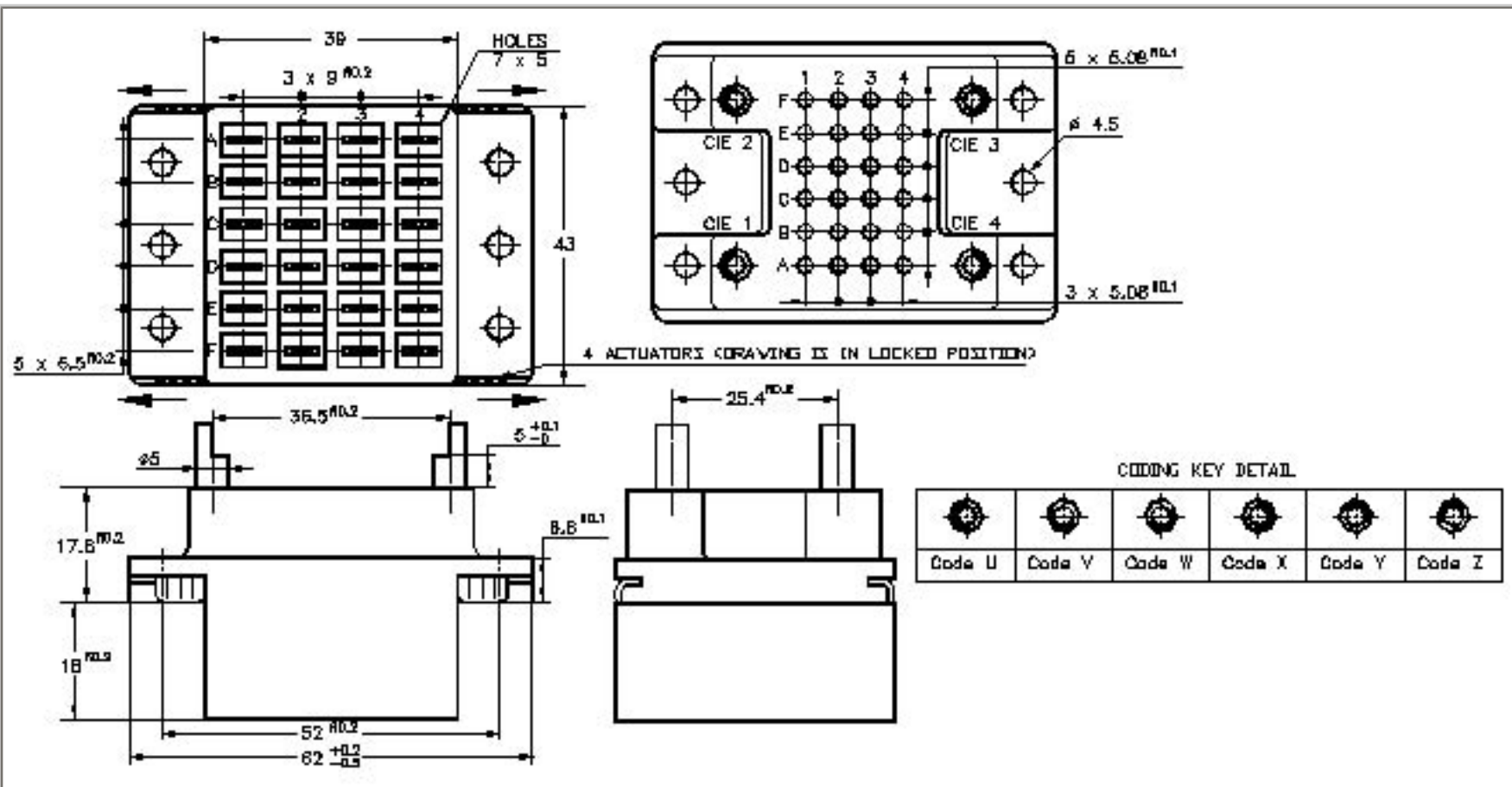

GENERAL CHARACTERISTICS

Base for F670 relay series with H mounting style. Foolproof mounting of the relay ensured by 4 keys according to NF F 62-002-2 FF n°8
Connections by 5 mm tabs according to ST363C

Contact Resistance	<5 mΩ
Maximum Current	15 Amps
Dielectric Strength	2625 Vrms / 50 HZ
Insulation Resistance	> 1000 MΩ at 100 Vdc
Weight	105 grams



Featuring **LEACH**® power and control solutions
www.leachintl.com

AMERICAS
6900 Orangethorpe Ave.
P.O. Box 5032
Buena Park, CA 90622 USA

EUROPE
2 Rue Goethe
57430 Sarralbe
France

ASIA
Room 501, 5/F, The Centre Mark
287 - 299 Queen's Road Central
Hong Kong

Tel: (01) 714-736-7599 Tel: (33) 3 87 97 31 01 Tel: (852) 2 191 3830
Fax: (01) 714-670-1145 Fax: (33) 3 87 97 96 86 Fax: (852) 2 389 5803

Data sheets are for initial product selection and comparison. Contact Leach International prior to choosing a component.

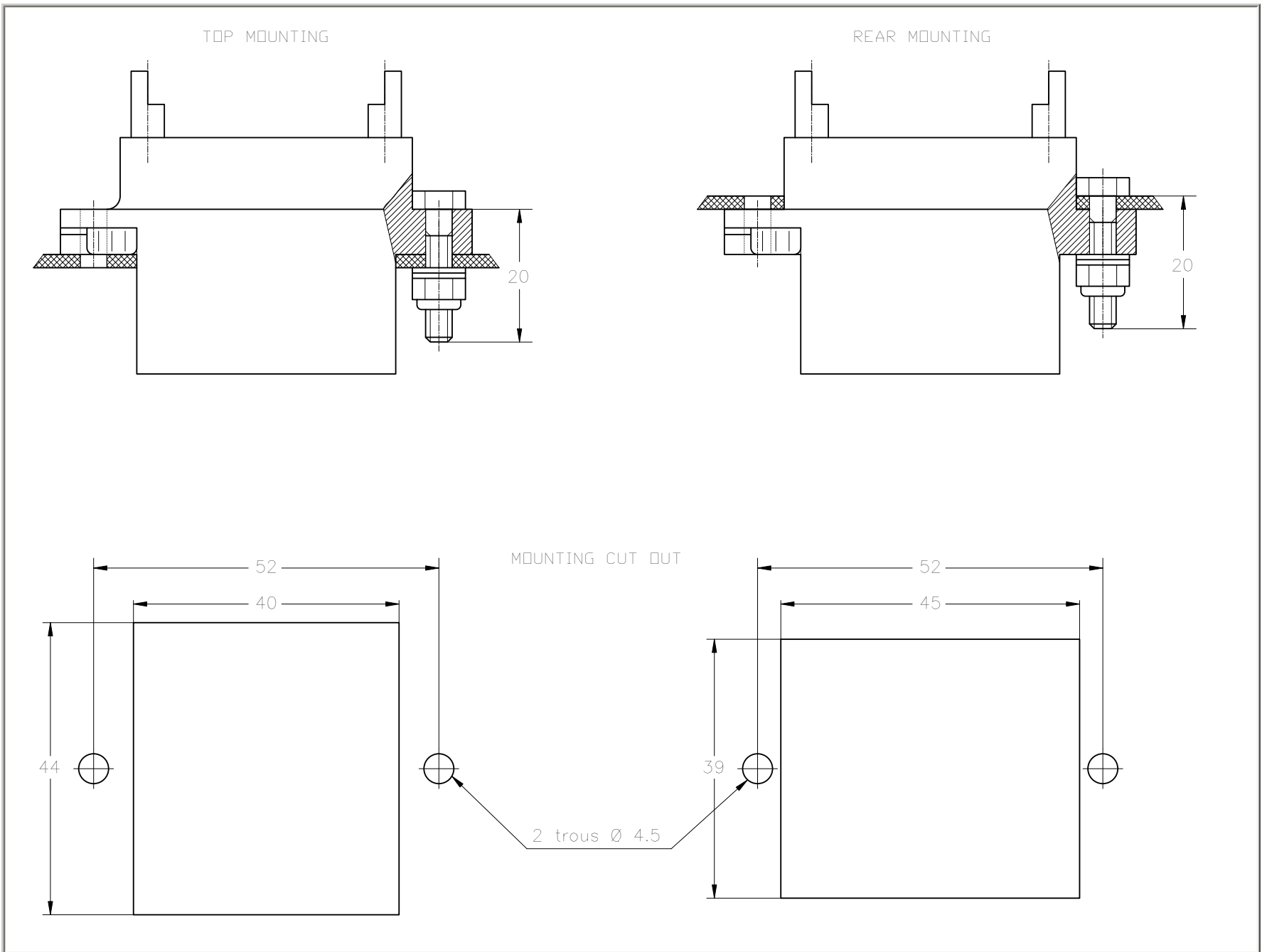

- Hardware:** (supplied with socket)
- 2 studs M4 - 2 self-locking nuts M4
 - 2 flat washers - 2 crinkle washers.