

SERIES H,HD,HP,HT,HTD,HPT

ENGINEERING DATA SHEET

CONTACTOR
60 AMP



APPLICATION NOTES:

- [101](#)
- [102](#)
- [104](#)
- [105](#)
- [007](#)

Balanced-Force Design
Hermetically sealed
Designed to the
performance standards of

MIL-PRF-6106

PRINCIPLE TECHNICAL CHARACTERISTICS

Contacts rated at **28 Vdc and 115 Vac, 400 Hz, 1 Ø and 115/200 Vac, 400Hz, 3Ø**

Weight **14.0 Oz.**

Special units available upon request, including models with auxiliary contacts. Optional Ground Fault Protection (GFP) feature available.

Contact factory for information on MIL-qualified part numbers.

CONTACT ELECTRICAL CHARACTERISTICS

Contact rating per pole and load type [1]	Load current in Amps					
	28 Vdc		115 Vac 400 Hz		115/200 Vac 400 Hz 3Ø	115 Vac 60 Hz DELTA
Resistive	50	50 [5]	60	65 [5]	60	30
Inductive [2]	20	20 [5]	60	65 [5]	60	30
Motor	20	-	-	-	40	30
Intermediate current	10	-	-	-	15	-
Load transfer [3]	-	-	12.5/60	12.5/60	12.5/60	-



Featuring **LEACH**® power and control solutions
www.esterline.com

AMERICAS
6900 Orangethorpe Ave.
P.O. Box 5032
Buena Park, CA 90622

Tel: (01) 714-736-7599
Fax: (01) 714-670-1145

EUROPE
2 Rue Goethe
57430 Sarralbe
France

Tel: (33) 3 87 97 31 01
Fax: (33) 3 87 97 96 86

ASIA
Units 602-603 6/F Lakeside 1
No.8 Science Park West Avenue
Phase Two, Hong Kong Science Park
Pak Shek Kok, Tai Po, N.T.
Hong Kong
Tel: (852) 2 191 3830
Fax: (852) 2 389 5803

Data sheets are for initial product selection and comparison. Contact Esterline Power Systems prior to choosing a component.

COIL CHARACTERISTICS (Vdc)**SERIES H,HD,HP,HT,HTD,HPT**

CODE	A Vdc	B Vdc	C Vdc	F Vac 400Hz	N [6] Vdc
Nominal operating voltage	28	12	6	115	28
Maximum operating voltage	29	14.5	7.3	124	29
Pick-up voltage, maximum					
- Nominal	18	9	4.5	90	18
- High temp test	20	10	5	95	20
- Continuous current test	22.5	11	5.7	100	22.5
Drop-out voltage, maximum	7	4.5	2.5	30	7
Coil resistance in Ohms $\pm 10\%$ at +25° C	200	50	12	-	200
Coil current max. mA at +25° C	-	-	-	90	-

GENERAL CHARACTERISTICS

Temperature range	-55°C to +71°C
Minimum operating cycles (life) at rated resistive load	50,000
Minimum operating cycles (life) at 25% rated resistive load	200,000
Dielectric strength at sea level	
- All circuits to ground and circuit to circuit	1500 Vrms
- Coil to ground and aux. contacts	1000 Vrms
Dielectric strength at altitude:50,000 feet	
- Main contacts	700 Vrms
- Coil and aux. contacts	500 Vrms
Insulation resistance	
- Initial	100 M Ω min
- After environmental tests	50 M Ω min
Sinusoidal vibration	10 G / 70 to 2000 Hz
Shock (6 ms duration)	50 G
Maximum contact opening time under vibration and shock	10 μ s
Operate time at nominal voltage (Including bounce)	50 ms max 35 ms max. [5]
Release time at nominal voltage (Including bounce)	
- DC	25 ms max
- AC	80 ms max
Contact bounce at nominal voltage	3 ms max
Weight	14.0 Oz. max. 11.5 Oz. max. [5]
Power requirements:	
- at pick-up +25° C	0.980 watt
- at nominal D.C. voltage	4.35 watt max.
Overload @ 115/200 Vac, 400Hz. @ 28 Vdc	400 Amp 125 Amp
Rupture @ 115/200 Vac, 400Hz. @ 28 Vdc	500 Amp 150 Amp

NUMBERING SYSTEM

SERIES H,HD,HP,HT,HTD,HPT

	H	-	X	0	X
	[7] HD	-	X	0	X
	[8] HP	-	X	0	X
	[4] HT	-	X	0	X
	[7] HTD	-	X	0	X
	[8] HTP	-	X	0	X
Relay family	_____				
1-Mounting Style(A,B,Etc.)	_____				
2-Terminal & Circuit (1,2,3,Etc.)	_____				
3-Coil Voltage(A,B,C,F & N)	_____				

NOTES

- [1] Auxiliary contact rating - see page 5, note [2].
- [2] Inductive load life, 20,000 cycles.
- [3] Applicable military specification: MS27751, MIL-R6106/26, MIL-R6106/43.
- [4] Suitable for transfer between unsynchronized A.C. power sources at the ratings indicated: 12.5 amperes for series "H, HD, HP"; (MS27751-1,-7,-8,-9,-10 & -15).
60 Amperes for series "HT, HTD, HTP"; (MS27751-11,-12,-17,-18,-19 & -20).
- [5] Terminal type 6, 8, & 10.
- [6] Suppressed "N" coil has back EMF suppression to 42 volts max. Consult factory.
- [7] Non-hermetic, gasket sealed version.
- [8] Non-hermetic, non-metallic cover gasket sealed version. (Not available with mounting style C).

CONFIGURATION STYLES

SERIES H,HD,HP,HT,HTD,HPT

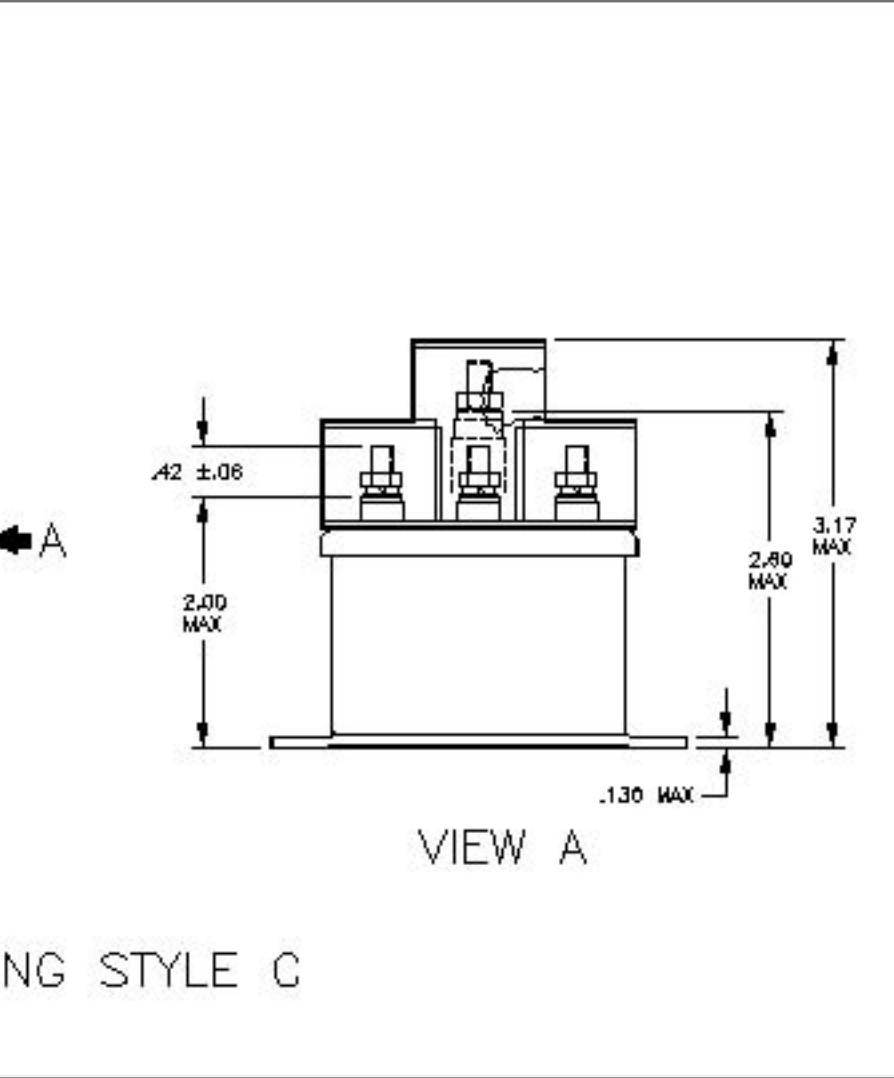
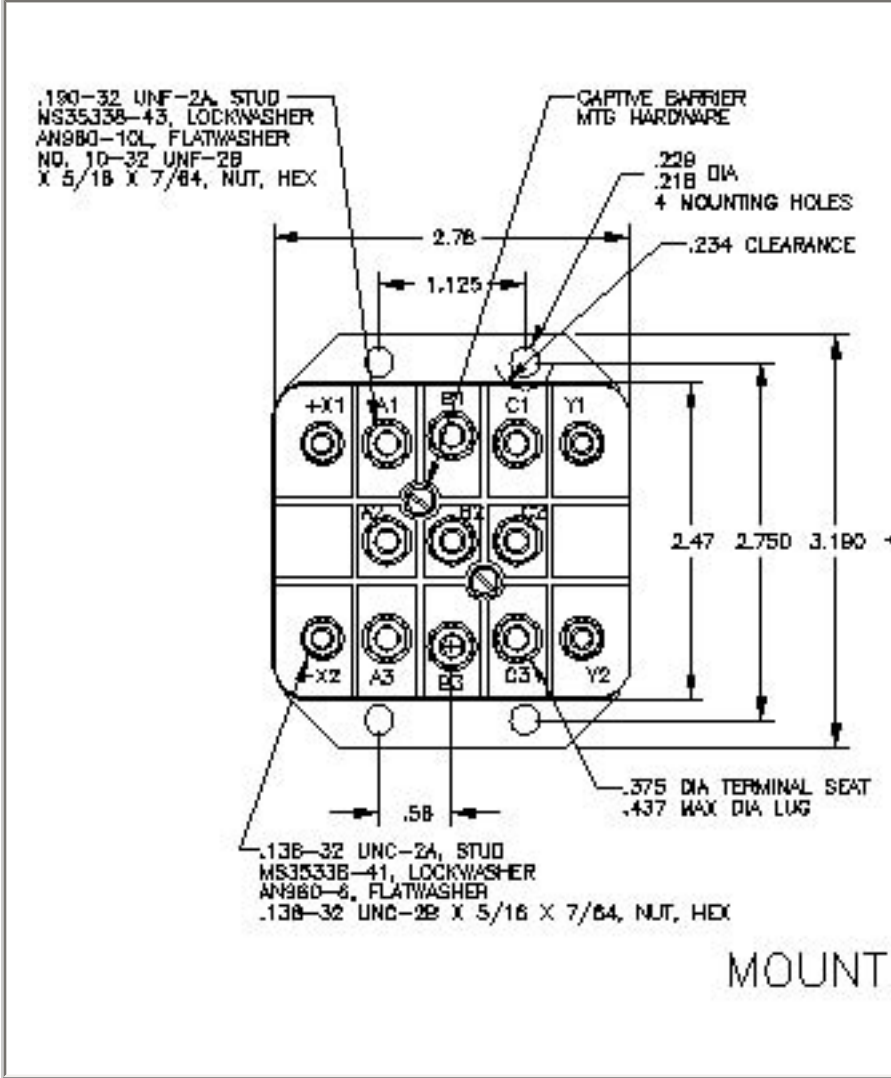
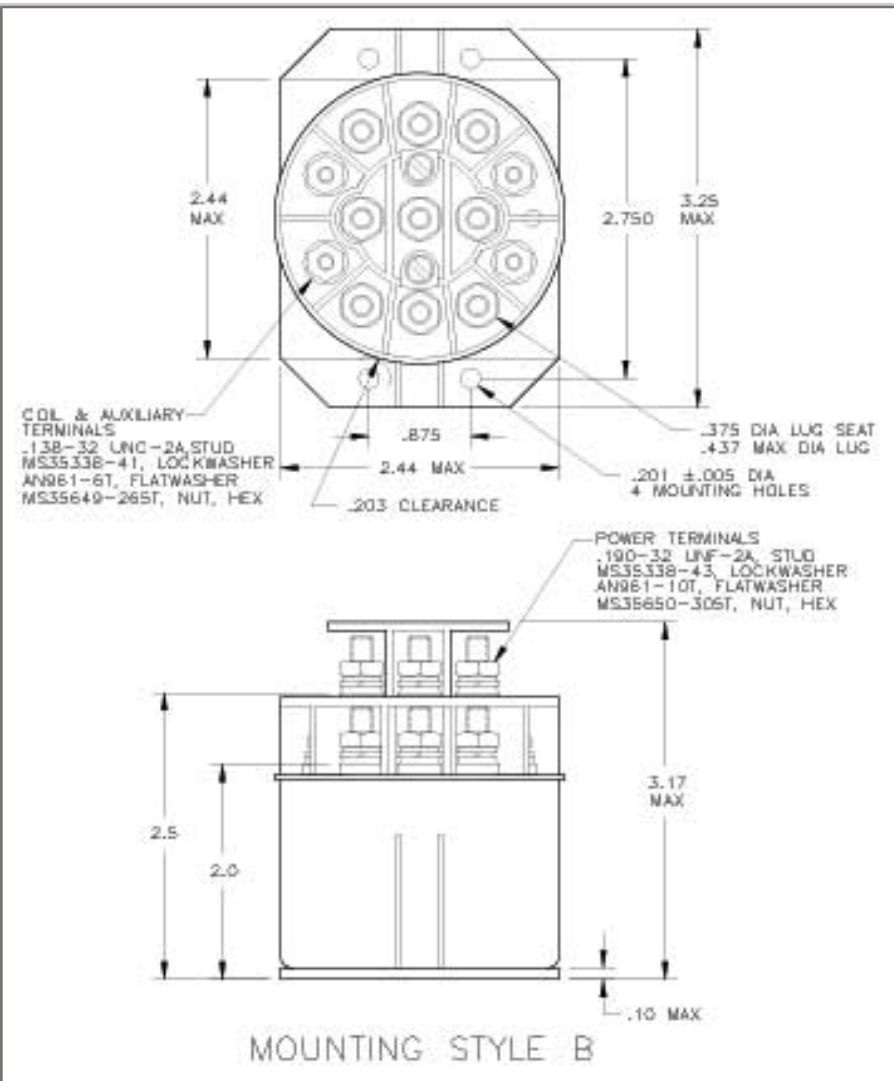
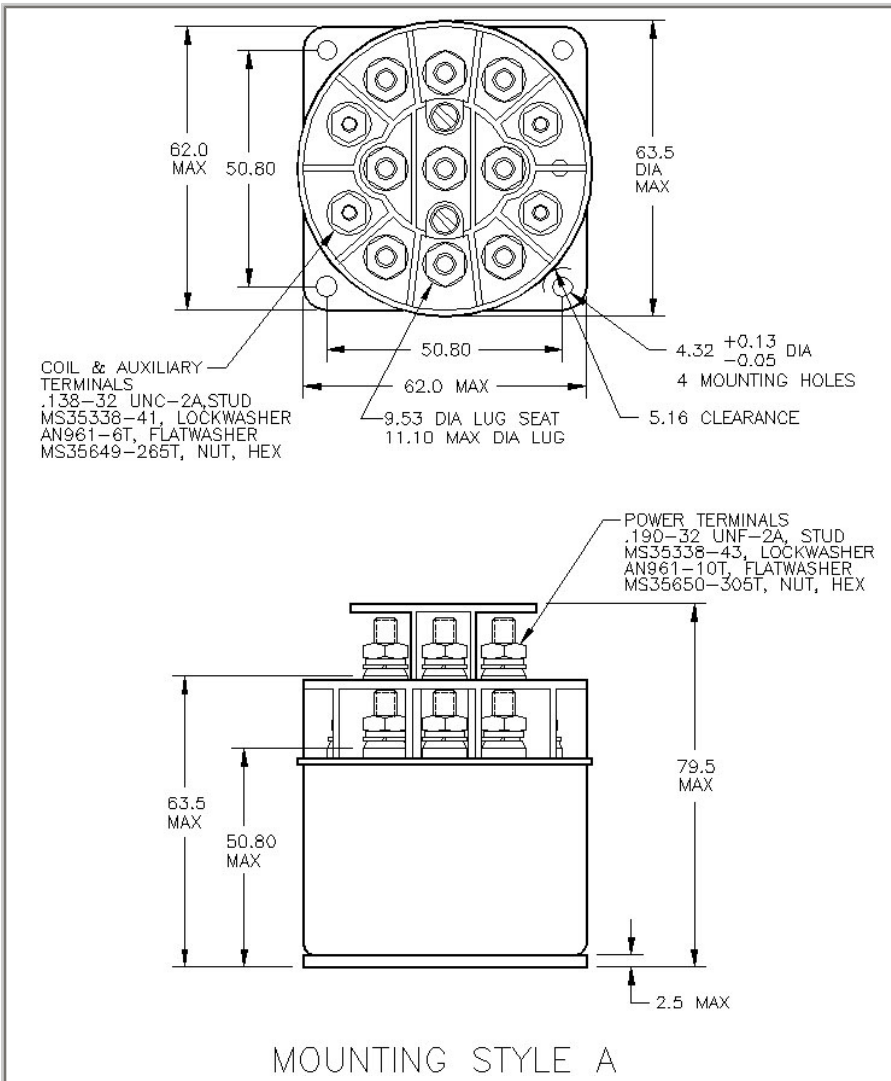

STANDARD TOLERANCE: XX ± .03, XXX ± .010

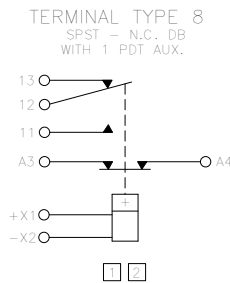
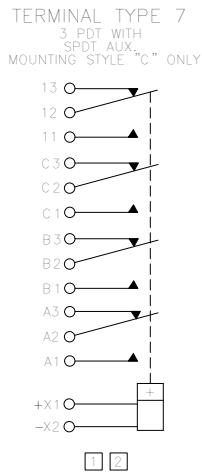
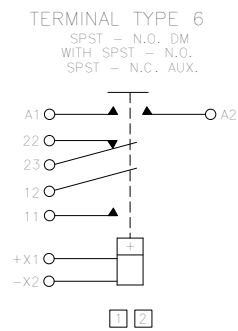
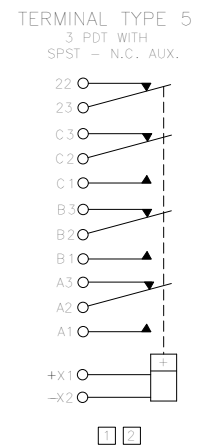
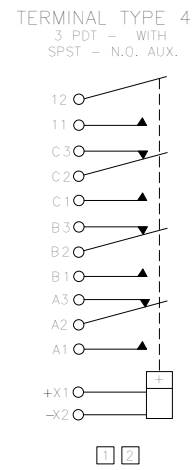
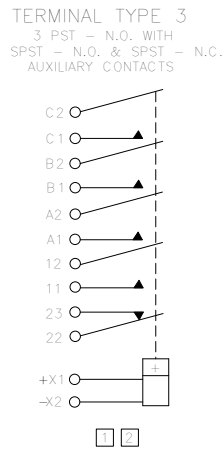
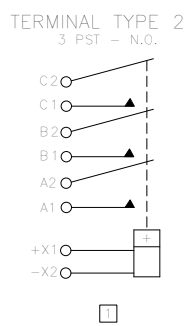
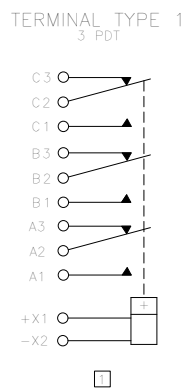

TERMINAL TYPE 9
IS A GENERAL CATEGORY USED FOR ALL
TERMINAL TYPES NOT ILLUSTRATED
FOR OTHER VARIATIONS OF TERMINAL
CONFIGURATIONS
PLEASE CONTACT FACTORY.

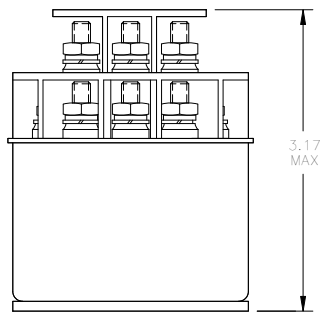
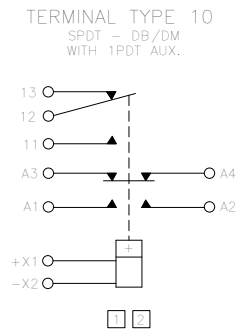

TERMINAL TYPE 1, 4, 5

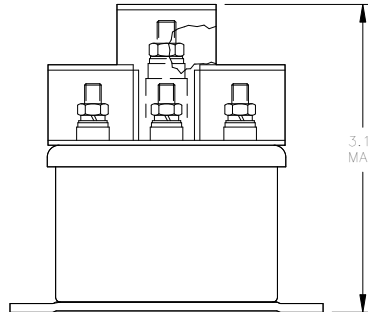

TERMINAL TYPE 7

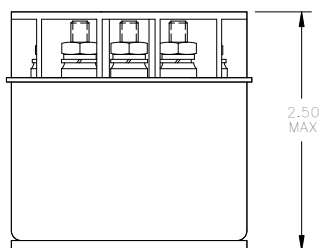

TERMINAL TYPE 2, 3, 6, 8, 10

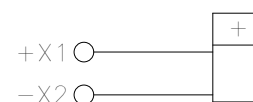

STANDARD
COIL
"A", "B", "C", "F"

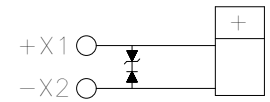

SUPPRESSED
COIL
"N"

1 POLARITY INDICATION APPLIES TO D.C. COILS ONLY

2 AUXILIARY CONTACT RATING:

28 VDC OR 115 VAC

RESISTIVE 5 AMP

INDUCTIVE 3 AMP

LAMP 1 AMP

CONTACT BOUNCE AT NOMINAL
VOLTAGE (SECONDS) .004 MAX

NOTE: OTHER AUXILIARY CONTACT FORMS ARE
AVAILABLE. PLEASE CONTACT FACTORY.

NOTE: Although all configuration and/or terminal type options are available, some combinations may require a setup charge and be subject to minimum order size.

DERATING OF CONTACTS FOR DC VOLTAGES ABOVE NOMINAL RATING

To establish a standard for the derating of relay contacts is, at best, a subjective practice. Limitations are governed by the type of relay, contact gap, maximum voltage capabilities of the relay contact system, and the contact material.

The most common method is to derate the contacts by use of the Power Formula, using the known current and voltage.

This method is valid only for **Resistive Loads**, and is an approximation only; keeping in mind the limitations mentioned above.

$$\text{Power} = IE \text{ (Current x Voltage)}$$

$$I_2 E_2 = 2/3 I_1 E_1$$

Example:

A designer is working with a 55 volt DC system and has a relay rated at 10 amps resistive at 28 volts DC. What is the maximum current that can be switched at 55 Vdc.

$$I_1 = 10 \text{ Amperes}$$

$$E_1 = 28 \text{ VDC}$$

$$E_2 = 55 \text{ VDC}$$

$$I_2 = ? \text{ (Current ratings at 55 VDC Resistive)}$$

$$I_2 E_2 = 2 I_1 E_1 / 3$$

$$I_2 = 2 I_1 E_1 / E_2 \cdot 3$$

$$= 2 (10 \times 28) / 55 \times 3$$

$$= 560 / 165$$

$$I_2 = 3.4 \text{ Amperes at 55VDC}$$

In addition, the user should always be concerned about the following:

1. Derating contacts that are rated for less than 10 Amperes at nominal voltage.
2. Derating contacts for use in system voltages above 130 Volts DC

RELAYS AND TEMPERATURE VARIATIONS

Most relay parameters are specified as maximum values over the rated temperature range of the specific relay. Users often find that key parameters differ significantly at ambient temperature (20-25°C) and sometimes fall into the trap of specifying their system around these ambient parameters. Additionally the actual temperature experienced by the relay can be far in excess of existing ambient temperatures due to the heat generated by the coil current and the contact load. Figure 1 is the summary of temperature effects on relay electrical characteristics.

Temperature	Resistance	Current	Operating Voltage	Release Voltage	Operate Time	Release Time
Increase	UP	DOWN	UP	UP	UP	UP
Decrease	DOWN	UP	DOWN	DOWN	DOWN	DOWN

Fig. 1

The following formulas are sometimes useful in calculating the effects shown above.

1. Change in coil resistance due to change of ambient temperature can be calculated by the following formula.

$$R = R_{20} [1 + .0039 (T-20)]$$

Where: R = Coil resistance at given temperature
 R₂₀ = Coil resistance at 20°C
 T = °C Ambient temperature

"Rule of Thumb" : For each 10°C change of temperature, coil resistance will change approximately 4%.

2. High and low temperature pick up voltage:

$$E_2 = E_1 K_2,$$

Where: E₂ = Pick Up Voltage at T₂ temperature
 E₁ = Pick Up Voltage at 20°C
 K₂ = Coefficient of correction found on the graph in Fig. 2 at T₂

3. Calculation of coil temperature rise when R initial and R final are known:

$$\Delta T = (234.5 + T_1) (R_2/R_1 - 1)$$

ΔT = Temperature rise ($^{\circ}\text{C}$)

T_1 = Initial temperature ($^{\circ}\text{C}$)

R_1 = Initial resistance (Ohms)

R_2 = Final resistance (Ohms)

$$R_2 = K_2 R_1$$

Temperature can also be found by making the R_2/R_1 ratio = the coefficient of correction graph in Fig. 2, and then finding the corresponding temperature.

TEMPERATURE CORRECTION CHART FOR RESISTANCE

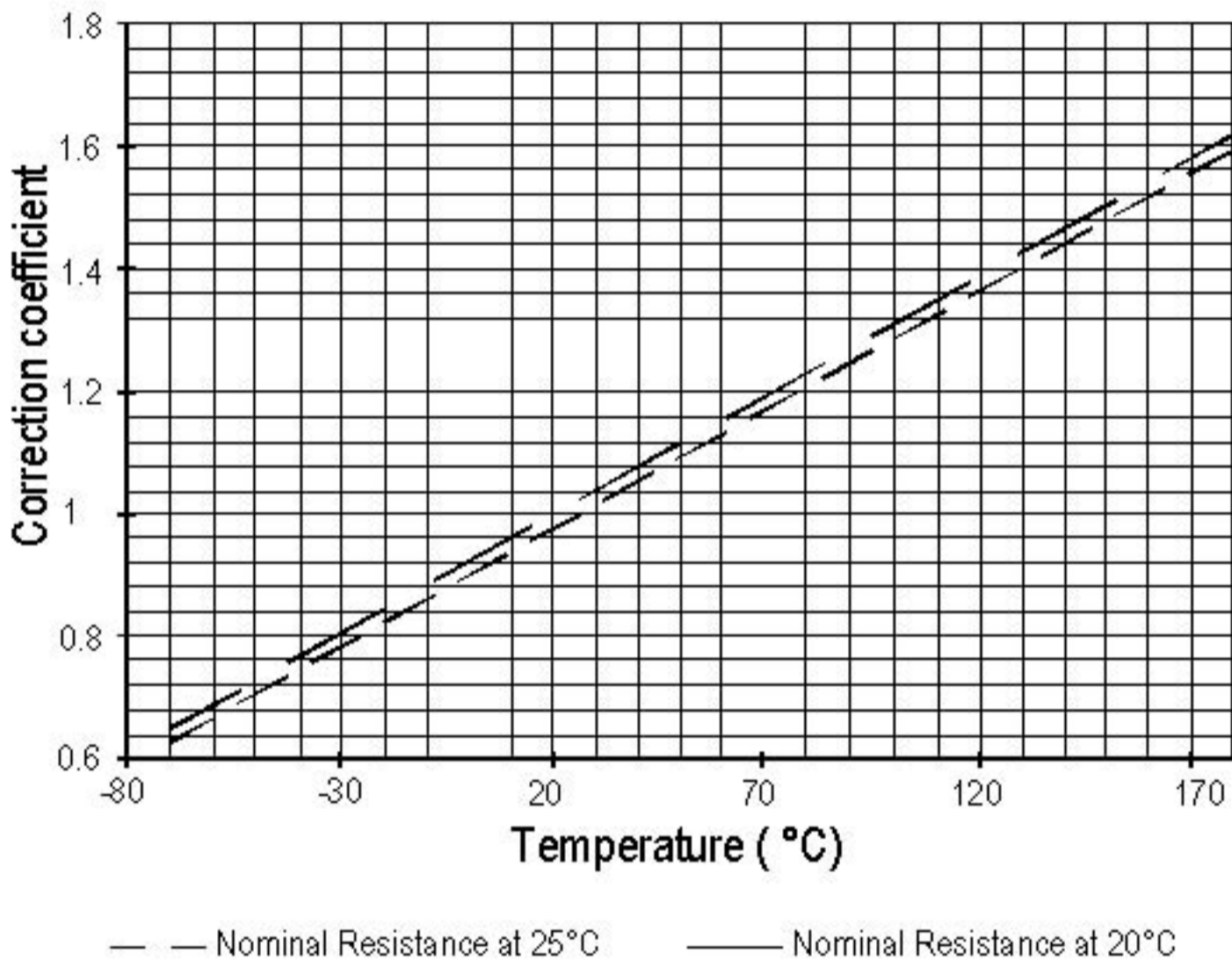

Fig. 2

EXAMPLE:

Catalog indicates coil resistance of 290 ohm at 25°C. What is the value at 125°C?

From the chart: $290 \times 1.39 = 403.31$ Ohms.

"SMART" CONTACTORS

SMART CONTACTORS are hybrid devices combining standard production power relays with an electronic module and electrical sensor. Their primary purpose is to control the flow of power to equipment without the use of the conventional circuit breaker panel. They are controlled by and provide information to a logic network or host computer.

The functions and requirements of "SMART CONTACTORS" will vary, depending on the power distribution or control system involved. Leach International provides "SMART" capability from 25 amperes to 305 amperes, single and three phase AC, and up to 1000 amperes DC.

In addition to I²t curves, devices can be configured to respond to current, voltage or power. The standard operating temperature range is -55°C to +71°C, and weights will vary in junction of the application.

The photos below show two current applications:

Fig. 1. Used in APU start circuit on board commercial aircraft.

Fig. 2. Used in three phase secondary bus distribution onboard military fighter aircraft.



Figure 1



Figure 2

AIRCRAFT GROUND FAULT DETECTION AND PROTECTION

Leach International, the innovator of the "Smart Contactor" in response to the need for ground fault protection, has developed several contactors with capabilities to detect and isolate ground faults. As aircraft become more electrical *and*, as existing aircraft age, the problems with wiring and wire harnesses become more significant. Incidents resulting in catastrophic loss of aircraft have been attributed to faults of this category. Conventional electromechanical protection devices, *i.e.*, circuit breakers are not suitable for detecting and isolating this type of fault. The use of a Ground Fault Sensing Contactor (GFSC) provides protection for personnel and equipment against this type of fault.

Ground Fault Concept

The concept of ground fault detection is an established and proven technique. A common method of fault detection is to compare the total electrical current flowing to the load with the current that returns from the load. A difference between these two values indicates that the current is returning to the source through an unexpected path, *i.e.*, ground fault.

Several configurations of these devices have been designed and developed for airborne applications and are currently flying on a number of commercial aircraft. These units have the capability to compare the load current through the device versus current measured by an external sensor and trip (open) the contactor if the difference between the current values exceeds a predefined level. The external sensor is normally used on the return path of the current to its source; therefore comparison is performed between the input current (to the load) and the output current (from the load).

LEACH Ground Fault Protection

The Ground Fault Protection (GFP) feature may be incorporated into existing Leach International products. The "H" contactor, for example, is a 3PDT device that is used extensively in aircraft and military vehicle electrical systems. This device, rated for



H Type Contactor with GFP

H Type Contactor

60 amperes, is fairly compact and light. Leach, using miniaturization techniques and exotic magnetic material has managed to incorporate the GFP within this assembly with minimal impact to its size. The interface and the footprint of this unit remains intact, allowing direct replacement of existing units with units featuring GFP. The height of the unit is increased by .40" and its weight is increased by only 2 ounces.

One of the major achievements with this design is the reduction in "release" time of the contactor. Due to potential danger of a fault, it should be expeditiously interrupted and isolated. The normal release time of the contactors (greater than 20 ms) is not acceptable for this application. Personnel injury (electrocution) and substantial damage to the wiring or aircraft equipment could occur within this period. It is imperative that the fault be detected and interrupted within 10 ms or faster to minimize the damage. Leach, with the aid of a proprietary circuit, has managed to reduce the release time of the contactor to less than 8 ms

without any degradation to its performance.

The GFP circuit can be incorporated in a majority of Leach International products including smaller relays. Obviously, the determinant for the size of the relay is the potential fault current.

SUPPRESSOR DEVICES FOR RELAY COILS

The inductive nature of relay coils allows them to create magnetic forces which are converted to mechanical movements to operate contact systems. When voltage is applied to a coil, the resulting current generates a magnetic flux, creating mechanical work. Upon deenergizing the coil, the collapsing magnetic field induces a reverse voltage (also known as back EMF) which tends to maintain current flow in the coil. The induced voltage level mainly depends on the duration of the deenergization. The faster the switch-off, the higher the induced voltage.

All coil suppression networks are based on a reduction of speed of current decay. This reduction may also slow down the opening of contacts, adversely effecting contact life and reliability. Therefore, it is very important to have a clear understanding of these phenomena when designing a coil suppression circuitry.

Typical coil characteristics

On the graph below, the upper record shows the contacts state. (High level NO contacts closed, low level NC contacts closed, intermediate state contact transfer). The lower record shows the voltage across the coil when the current is switched off by another relay contact.

The surge voltage is limited to -300V by the arc generated across contact poles. Discharge duration is about 200 microseconds after which the current change does not generate sufficient voltage. The voltage decreases to the point where the contacts start to move, at this time, the voltage increases due to the energy contained in the NO contact springs. The voltage decreases again during transfer, and increases once more when the magnetic circuit is closed on permanent magnet.

Operating times are as follows:

Time to start the movement 1.5ms

Total motion time 2.3ms

Transfer time 1.4ms

Contact State

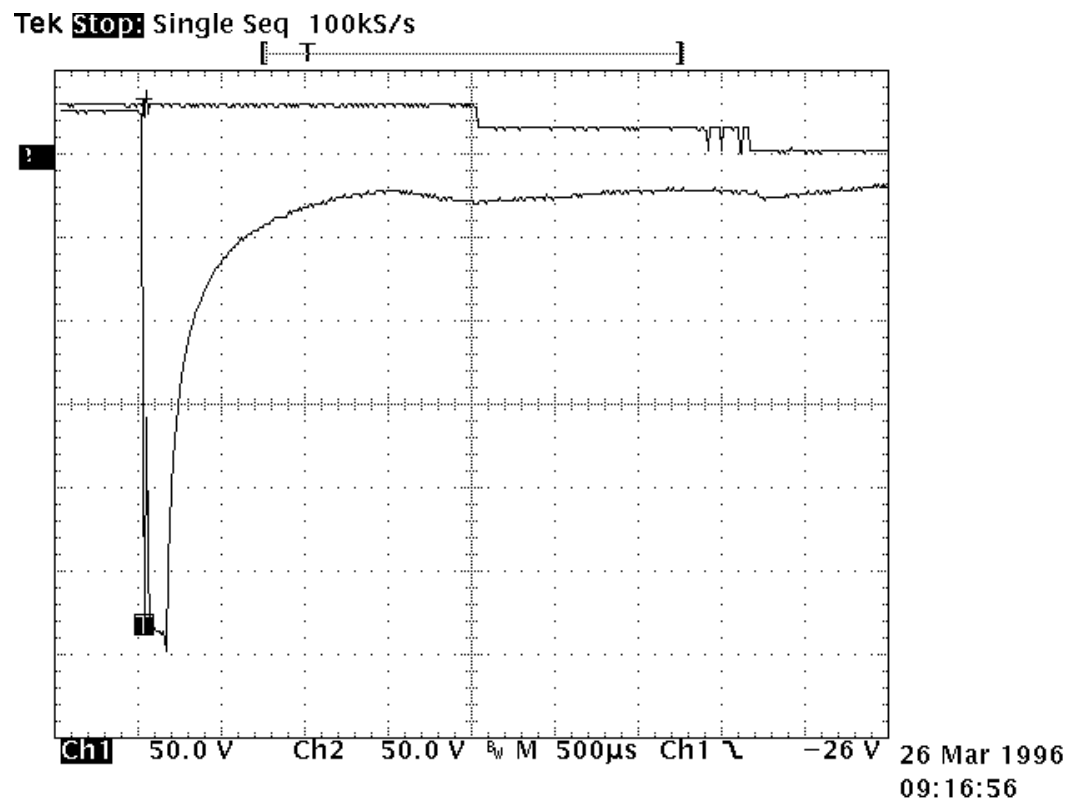

Types of suppressors:

Passive devices.

The resistor capacitor circuit

It eliminates the power dissipation problem, as well as fast voltage rises. With a proper match between coil and resistor, approximate capacitance value can be calculated from:

$$C = 0.02 \times T/R, \text{ where}$$

T = operating time in milliseconds

R = coil resistance in kiloOhms

C = capacitance in microFarads

The series resistor must be between 0.5 and 1 times the coil resistance. Special consideration must be taken for the capacitor inrush current in the case of a low resistance coil.

The record shown opposite is performed on the same relay as above. The operation time becomes:

- time to start the movement 2.3ms

- transfer time 1.2ms

The major difficulty comes from the capacitor volume. In our example of a relay with a 290Ω coil and time delay of 8 ms, a capacitance value of $C=0.5 \mu\text{F}$ is found. This non polarized capacitor, with a voltage of 63V minimum, has a volume of about 1cm^3 . For 150V, this volume becomes 1.5cm^3 .

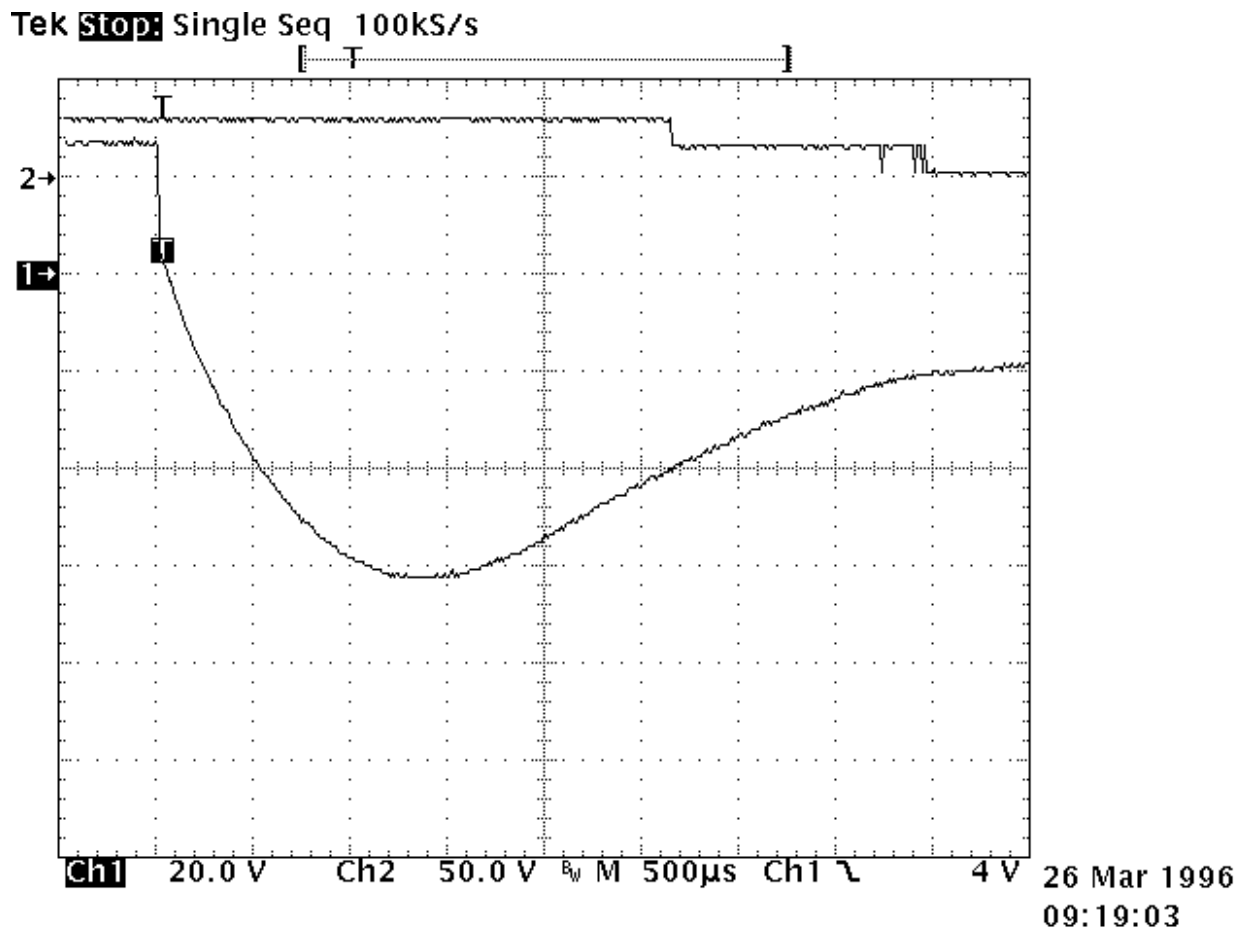

The bifilar coil

The principle is to wind on the magnetic circuit of the main coil a second coil shorted on itself. By a proper adaptation of the internal resistance of this second coil it is possible to find an acceptable equilibrium between surge voltage and reduction of the opening speed. To be efficient at fast voltage changes, the coupling of two coils must be perfect. This implies embedded windings. The volume occupied by the second coil reduces the efficiency of the main coil and results in higher coil power consumption. This method cannot be applied efficiently to products not specifically designed for this purpose.

The resistor (parallel with the coil)

For efficient action, the resistor must be of the same order of magnitude as the coil resistance. A resistor 1.5 times the coil resistance will limit the surge to 1.5 times the supply voltage. Release time and opening speed are moderately affected. The major problem is the extra power dissipated.

Semi-conductor devices

The diode

It is the most simple method to totally suppress the surge voltage. It has the major disadvantage of the higher reduction of contact opening speed. This is due to the total recycling, through the diode, of the energy contained in the coil itself. The following measurement is performed once again on the same relay. Operation times are given by the upper curve:

- time to start the movement 14ms
- transfer time 5ms

These times are multiplied by a coefficient from 4 to 8.

The lower curve shows the coil current. The increase prior to NO contact opening indicates that the contact spring dissipates its energy. At the opening time the current becomes constant as a result of practically zero opening speed.

Due to this kind of behavior, this type of suppression must be avoided for power relays. For small relays which have to switch low currents of less than 0.2 A, degradation of life is not that significant and the method may be acceptable.

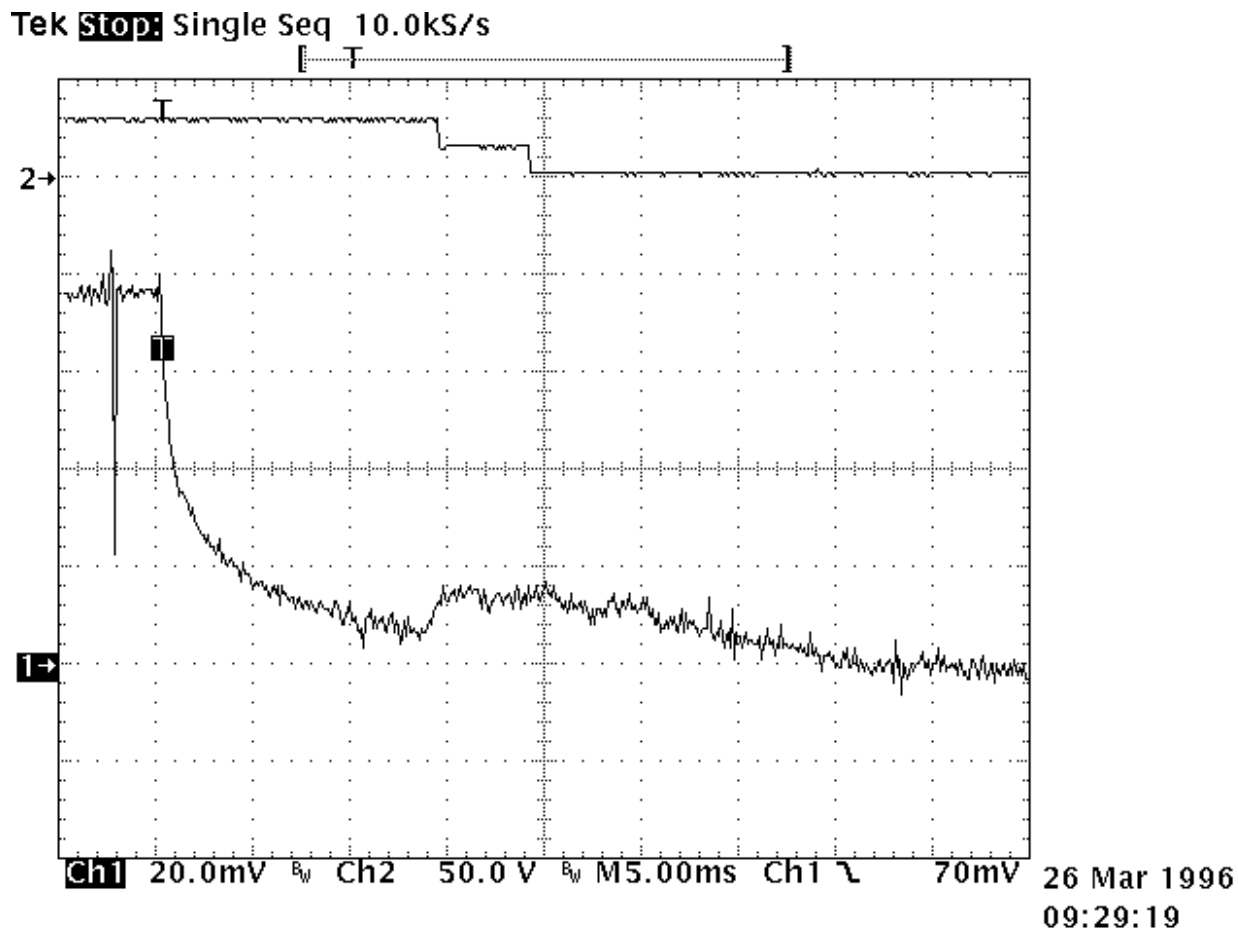

The diode + resistor network

It eliminates the inconvenience of the resistor alone, explained above, and it limits the action of a single diode. It is now preferred to use the diode + zener network.

The diode + zener network

Like the resistor, the zener allows a faster decurrent decay. In addition it introduces a threshold level for current conduction which avoids the recycling of energy released during contact movement.

The lower curve on the opposite record demonstrates those characteristics. Voltage limitation occurs at 42V. The two voltage spikes generated by internal movement are at lower levels than zener conduction. As a result, no current is recycled in the coil.

The opening time phases are as follows:

- time to start the movement 2.6ms
- total motion time 2.4ms
- transfer time 1.4ms

The release time is slightly increased. The contacts' opening speed remains unchanged.

